

# MİMARİ KATALOG ARCHITECTURAL CATALOGUE

Alüminyum Kapı Pencere ve Giydirme Cephe Sistemleri  
Aluminium Window Doors and Facade Systems

# RSS

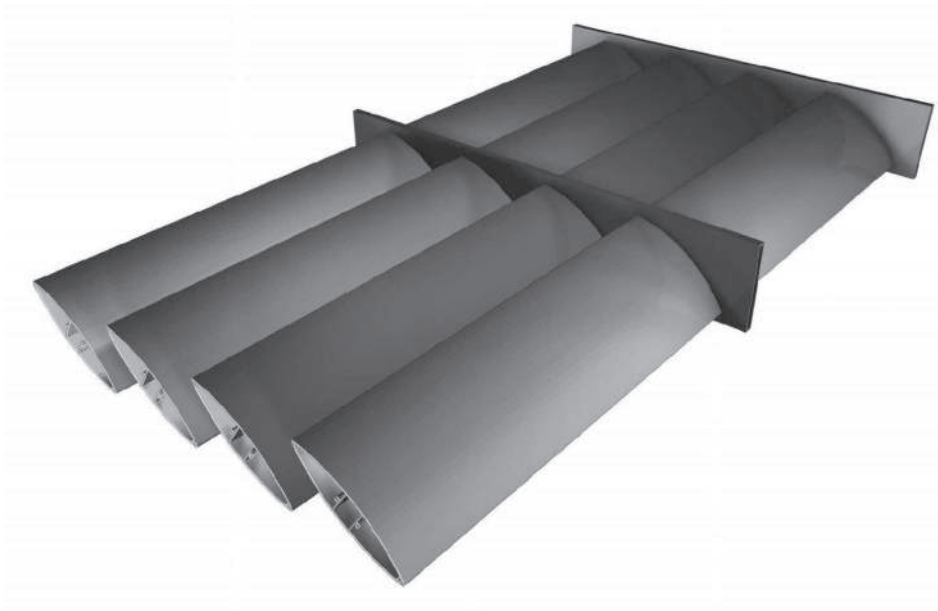



# MİMARİ KATALOG

## ARCHITECTURAL CATALOGUE

Alüminyum Kapı Pencere ve Giydirme Cephe Sistemleri  
Aluminium Window Doors and Facade Systems

# RSS

PROFİLLER

PROFILES

01

02

03

04

05

06

KOD / CODE	AĞIRLIK (kg/m) / WEIGHT	L m	KOD / CODE	AĞIRLIK (kg/m) / WEIGHT	L m
SOLAR P 03	0,944	6	SOLAR P 02	2,925	6
SOLAR P 17	1,057	6	SOLAR P 16	4,406	6
SOLAR P 19	1,529	6	SOLAR P 34	2,626	6



01

SOLAR P 03

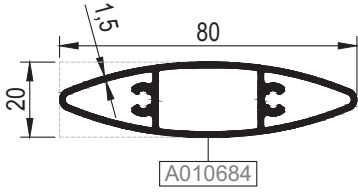

SOLAR P 17

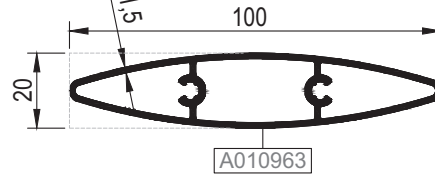

02

SOLAR P 19

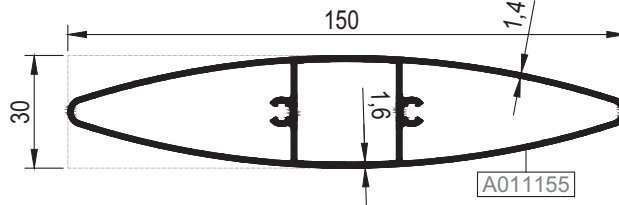

03

SOLAR P 34

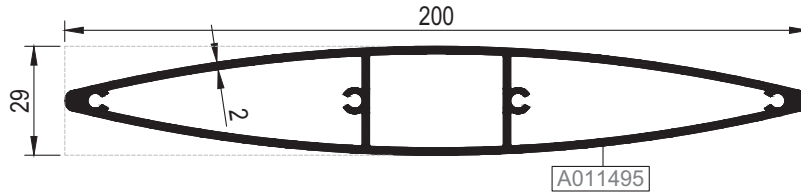

04

SOLAR P 02

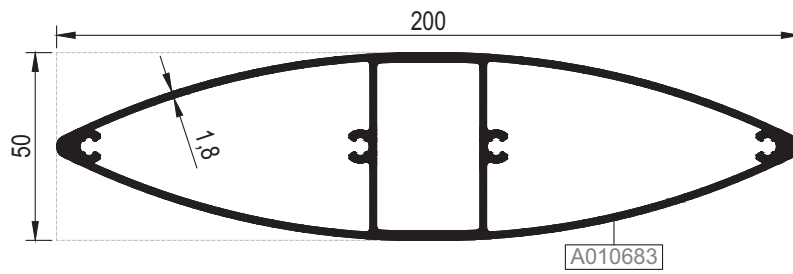

05

06

SOLAR P 16

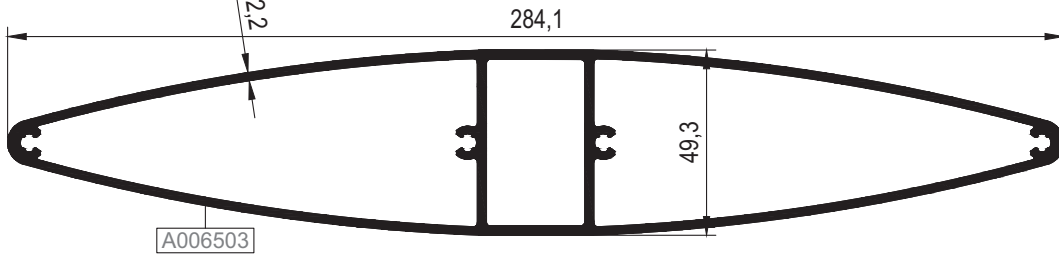

Ölçek/Scale: 1/2

KOD / CODE	AĞIRLIK (kg/m) / WEIGHT	L m	KOD / CODE	AĞIRLIK (kg/m) / WEIGHT	L m
SOLAR P 24	4,182	6	SOLAR P 27	6,677	6
1148	0,980	6	SOLAR P 32	3,905	6
1147	1,817	6			

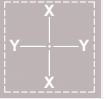

SOLAR P 24

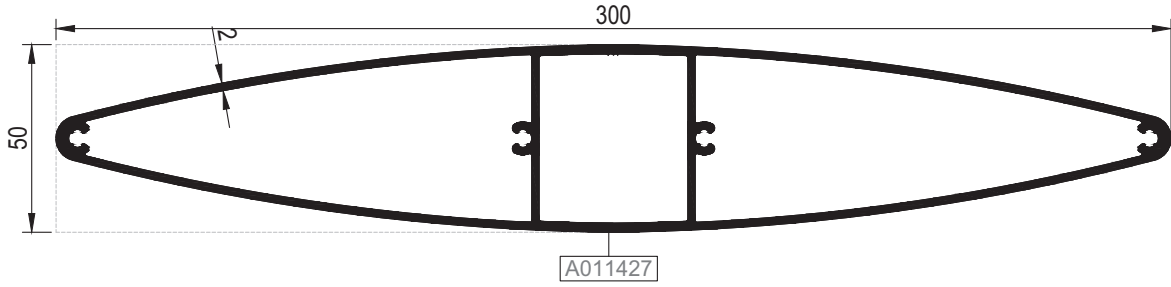

SOLAR P 32

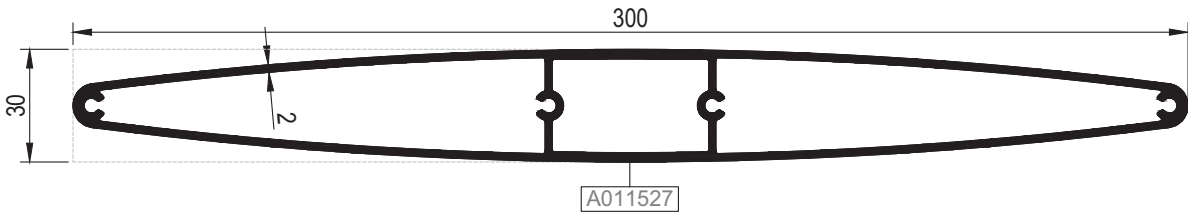

SOLAR P 27

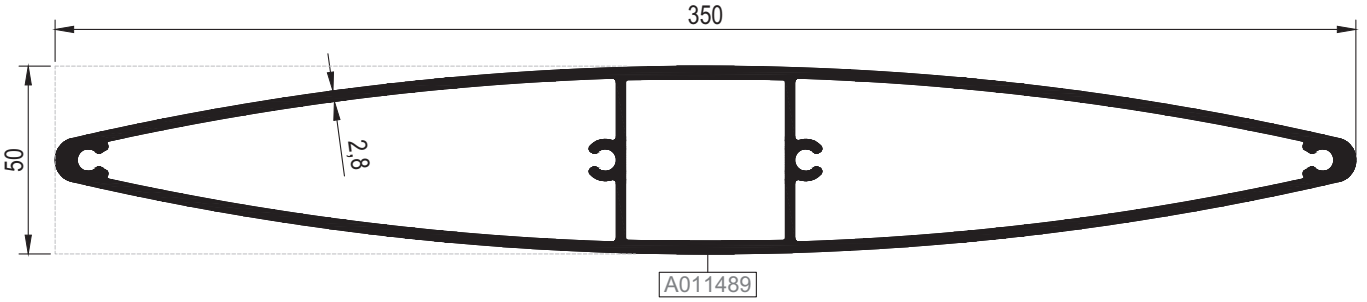

A001148

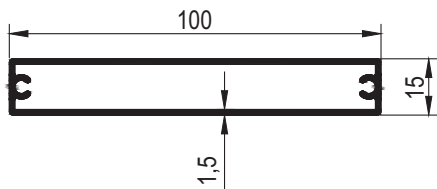

A001147

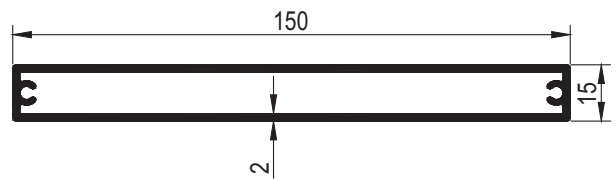

Ölçek/Scale: 1/2

KOD / CODE	AĞIRLIK (kg/m) / WEIGHT	L m	KOD / CODE	AĞIRLIK (kg/m) / WEIGHT	L m
SOLAR P 20	9,677	6			
SOLAR P 21	7,033	6			

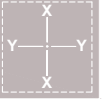

01

02

03

04

05

06

SOLAR P 20

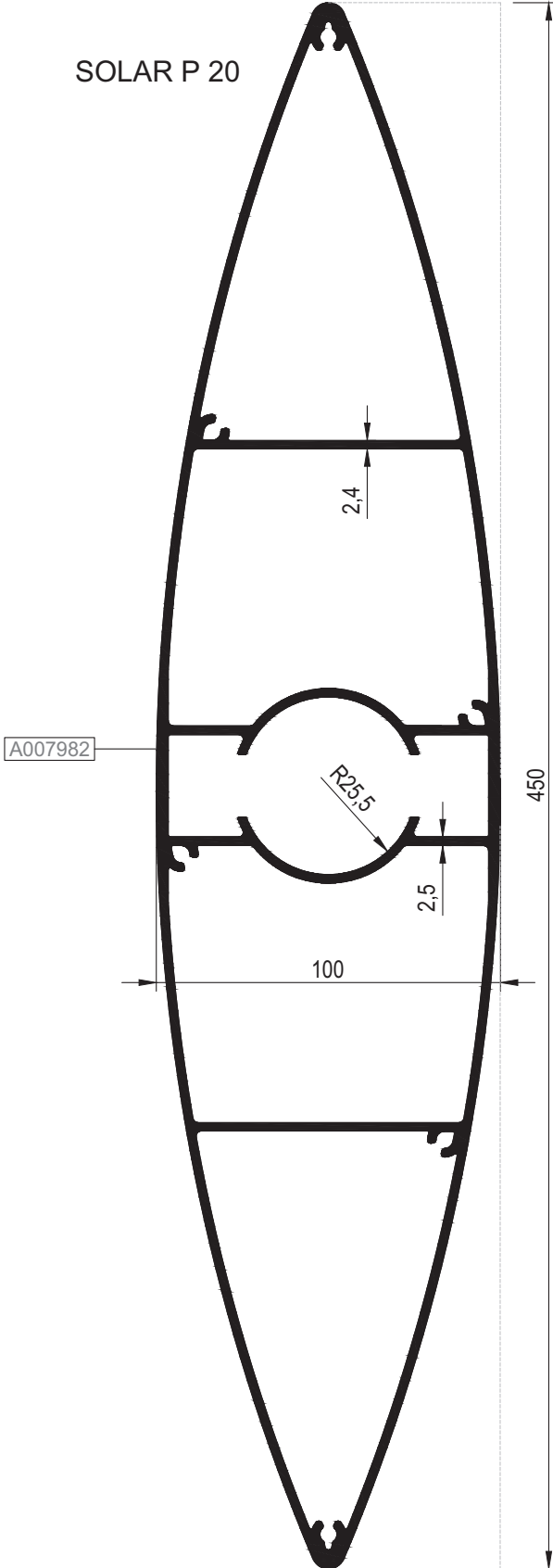

SOLAR P 21

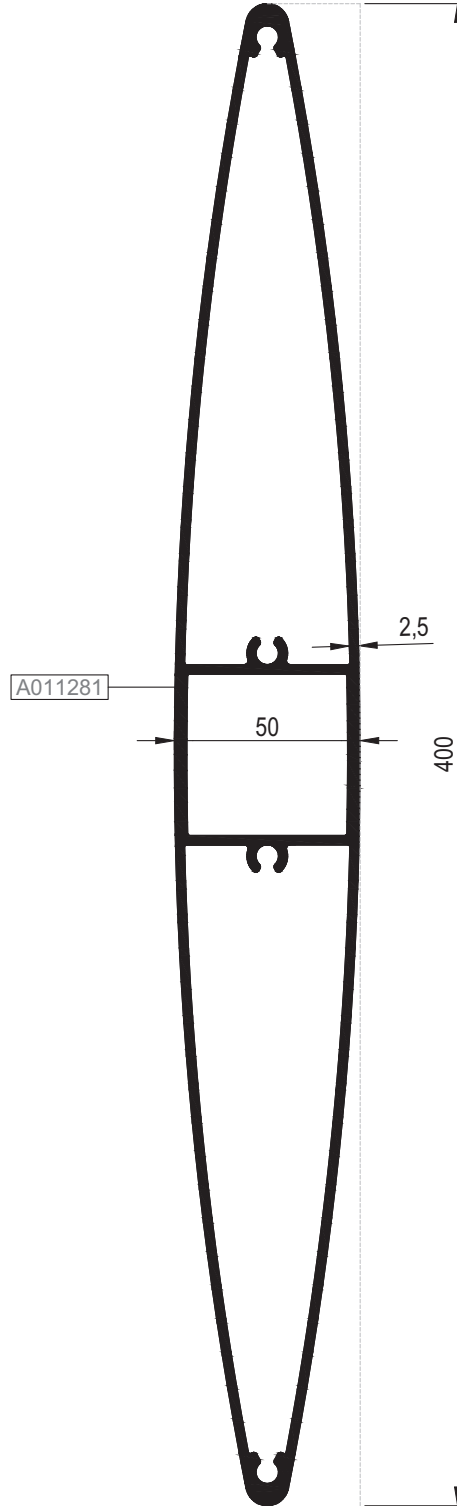

Ölçek/Scale: 1/2

KOD / CODE	AĞIRLIK (kg/m) / WEIGHT	L m	KOD / CODE	AĞIRLIK (kg/m) / WEIGHT	L m
SOLAR P 22	2,305	6	SOLAR P 13	1,785	6
SOLAR P 26	1,679	6	SOLAR P 14	1,570	6

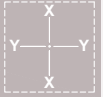

SOLAR P 22

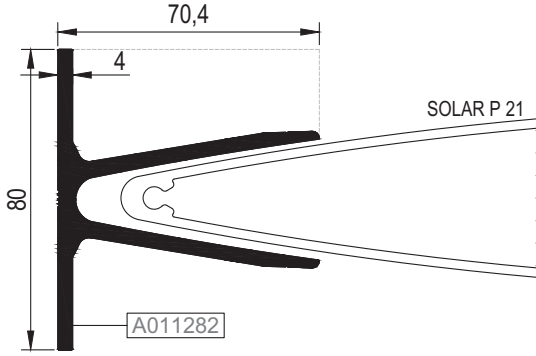

SOLAR P 21 İÇİN / FOR SOLAR P 21

SOLAR P 26

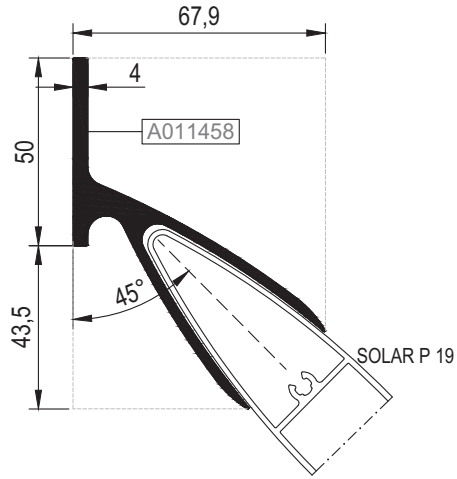

SOLAR P 19 İÇİN / FOR SOLAR P 19

SOLAR P 13

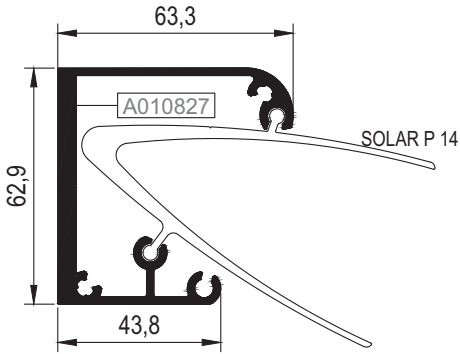

SOLAR P 14 İÇİN / FOR SOLAR P 14

SOLAR P 14

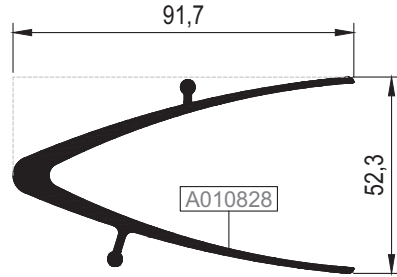

SOLAR P 02 İÇİN / FOR SOLAR P 02

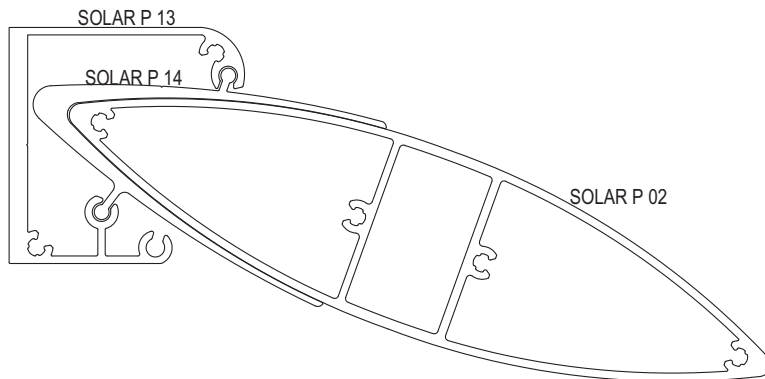

Ölçek/Scale: 1/2

KOD / CODE	AĞIRLIK (kg/m) / WEIGHT	L m	KOD / CODE	AĞIRLIK (kg/m) / WEIGHT	L m
SOLAR P 28	1,582	6	SOLAR P 31	2,411	6
SOLAR P 29	2,385	6	SOLAR P 33	1,672	6
SOLAR P 30	2,192	6	SOLAR P 41	2,320	6

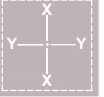

01

SOLAR P 28

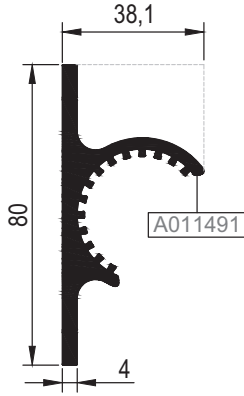

02

SOLAR P 29

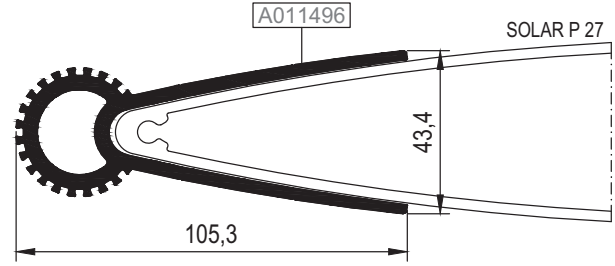

SOLAR P 27 İÇİN / FOR SOLAR P 27

03

SOLAR P 30

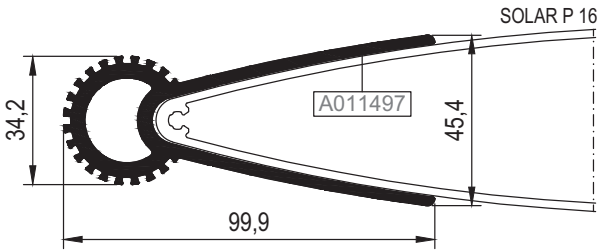

SOLAR P 16 İÇİN / FOR SOLAR P 16

04

SOLAR P 31

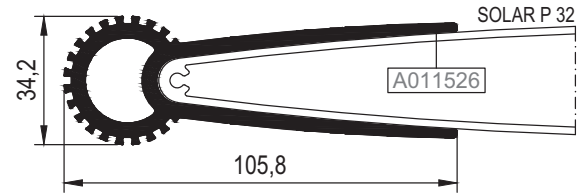

SOLAR P 32 İÇİN / FOR SOLAR P 32

05

SOLAR P 33

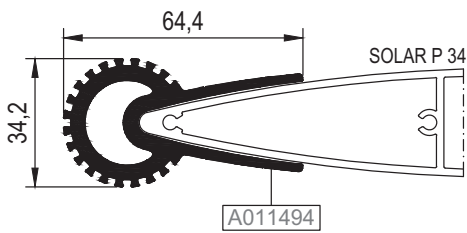

SOLAR P 34 İÇİN / FOR SOLAR P 34

06

SOLAR P 41

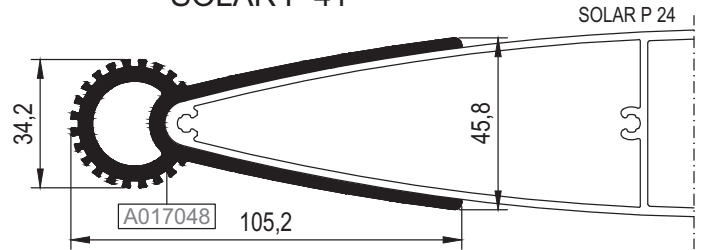

SOLAR P 24 İÇİN / FOR SOLAR P 24

Ölçek/Scale: 1/2



KOD / CODE	AĞIRLIK (kg/m) / WEIGHT	L m	KOD / CODE	AĞIRLIK (kg/m) / WEIGHT	L m
SOLAR P 35	0,541	6	SOLAR P 38	2,757	6
SOLAR P 36	0,967	6	SOLAR P 39	0,193	6
SOLAR P 37	1,466	6			

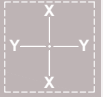

SOLAR P 35

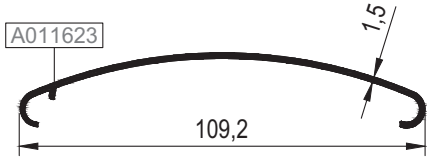

SOLAR P 38 İÇİN / FOR SOLAR P 38

SOLAR P 36

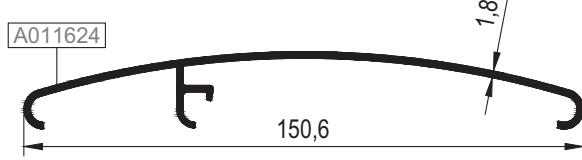

SOLAR P 38 İÇİN / FOR SOLAR P 38

SOLAR P 37

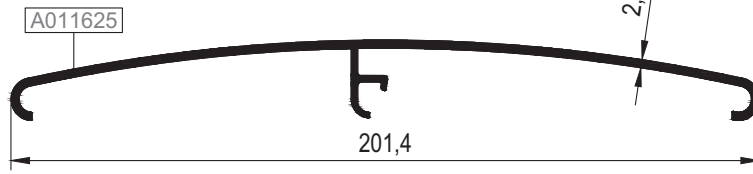

SOLAR P 38 İÇİN / FOR SOLAR P 38

SOLAR P 38

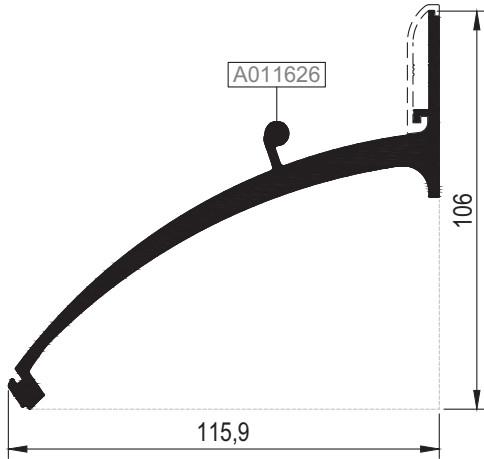

SOLAR P 39

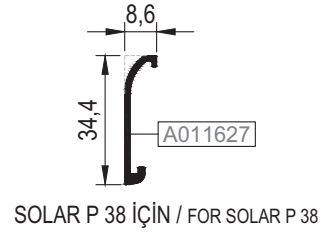

SOLAR P 38 İÇİN / FOR SOLAR P 38

Ölçek/Scale: 1/2

STOKTA BULUNAN SİSTEM PROFİLLERİNİN LİSTESİ (LIST OF SYSTEM PROFILES IN STOCK)

Nr	MIN. SİPARİŞ MİKTARI MIN. ORDER QUANTITY
SOLAR P 17 A010963	75 kg

\* STOKTA BULUNMAYAN TÜM PROFİLLER İÇİN MİNİMUM SİPARİŞ MİKTARI 300 KG'DIR.  
MINIMUM ORDER QUANTITY FOR ALL THE PROFILES THAT ARE NOT IN STOCK IS 300 KG.



# MİMARİ KATALOG

## ARCHITECTURAL CATALOGUE

Alüminyum Kapı Pencere ve Giydirme Cephe Sistemleri  
Aluminium Window Doors and Facade Systems

# RSS

DETAYLAR

DETAILS

01

02

03

04

05

06

SOLAR P 02, SOLAR P 13, SOLAR P 14 İLE DETAY  
DETAIL WITH SOLAR P 02 ,SOLAR P 13, SOLAR P 14

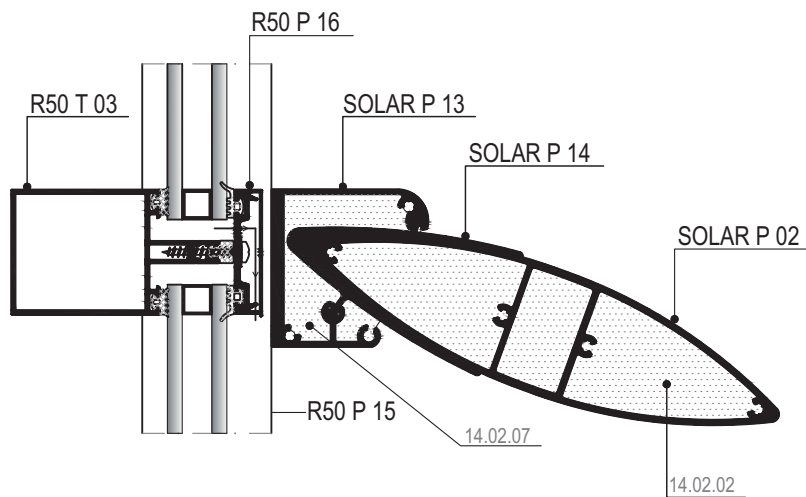
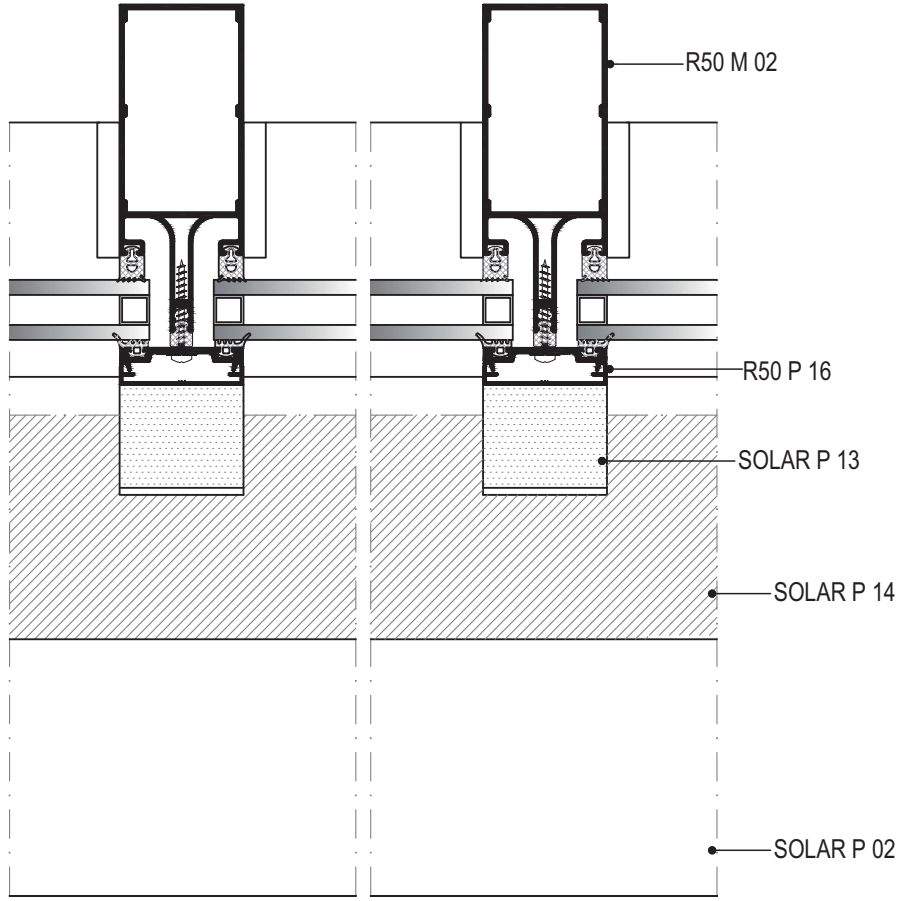

SOLAR P 28, SOLAR P 31, SOLAR P 32 İLE DETAY  
DETAIL WITH SOLAR P 28 ,SOLAR P 31, SOLAR P 32

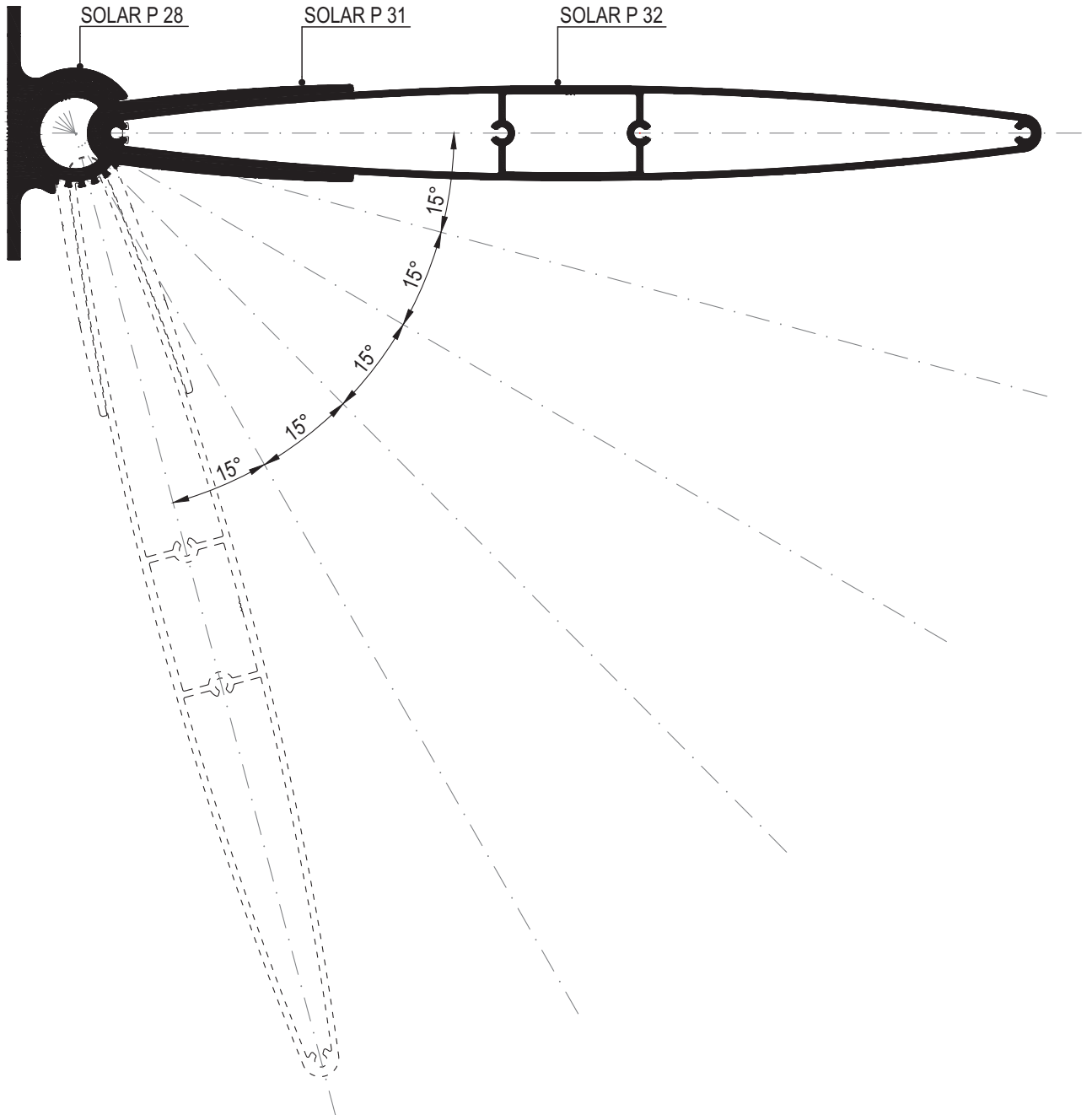

01

02

03

04

05

06

SOLAR P 35-36-37, SOLAR P 38, SOLAR P 39 İLE DETAY  
DETAIL WITH SOLAR P 35-36-37, SOLAR P 31, SOLAR P 32

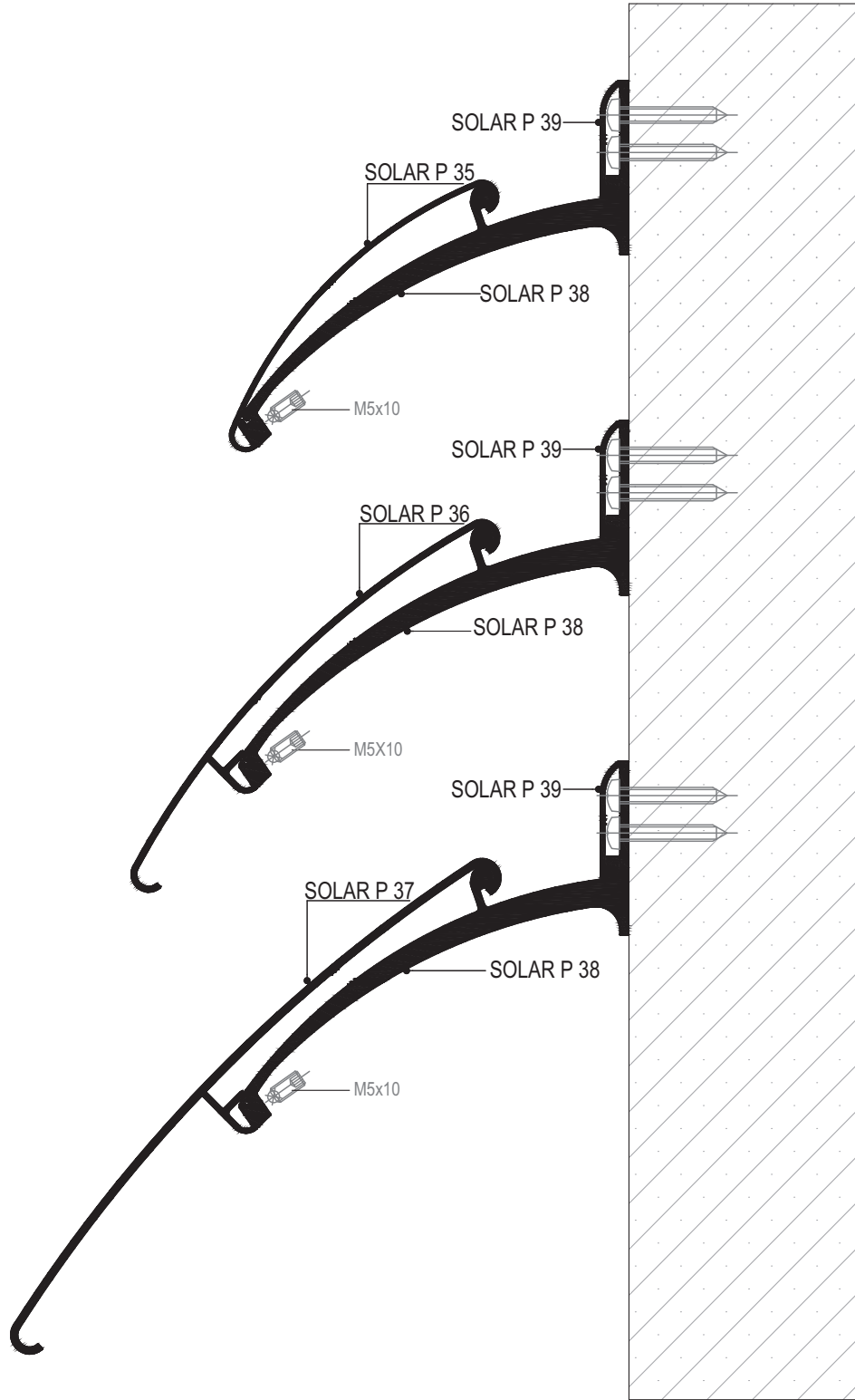

# MİMARİ KATALOG ARCHITECTURAL CATALOGUE

Alüminyum Kapı Pencere ve Giydirme Cephe Sistemleri  
Aluminium Window Doors and Facade Systems

# RSS

AKSESUARLAR

ACCESSORIES

01











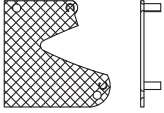
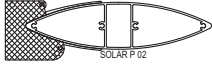

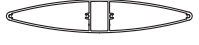
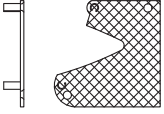
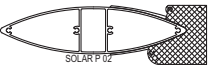

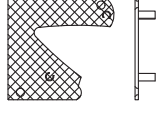
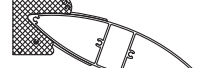

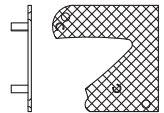
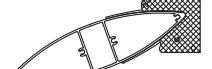

02

03

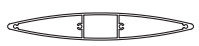
04

05

06

01	 <p><b>14.02.05</b> YAN KAPAK SOL CAP-LEFT Malzeme / Material: - PVC</p>	 <p>SOLAR P 13 (10827)</p>	 <p><b>14.02.09</b> YAN KAPAK CAP Malzeme / Material: - Alüminyum</p>	 <p>SOLAR P 16 (A006503)</p>
02	 <p><b>14.02.06</b> YAN KAPAK SAĞ CAP-RIGHT Malzeme / Material: - PVC</p>	 <p>SOLAR P 13 (10827)</p>	 <p><b>14.02.10</b> YAN KAPAK CAP Malzeme / Material: - Alüminyum</p>	 <p>SOLAR P 02 (A010683)</p>
03	 <p><b>14.02.07</b> YAN KAPAK SOL CAP-LEFT Malzeme / Material: - PVC</p>	 <p>SOLAR P 13 (10827)</p>	 <p><b>14.02.11</b> YAN KAPAK CAP Malzeme / Material: - Alüminyum</p>	 <p>SOLAR P 03 (A010684)</p>
04	 <p><b>14.02.08</b> YAN KAPAK SAĞ CAP-RIGHT Malzeme / Material: - PVC</p>	 <p>SOLAR P 13 (10827)</p>	 <p><b>14.02.12</b> YAN KAPAK CAP Malzeme / Material: - Alüminyum</p>	 <p>SOLAR P 24 (A011427)</p>
05	 <p><b>14.02.01</b> YAN KAPAK CAP Malzeme / Material: - Alüminyum</p>	 <p>SOLAR P 16 (A006503)</p>	 <p><b>14.02.13</b> YAN KAPAK CAP Malzeme / Material: - Alüminyum</p>	 <p>SOLAR P 34 (A011495)</p>
06	 <p><b>14.02.02</b> YAN KAPAK CAP Malzeme / Material: - Alüminyum</p>	 <p>SOLAR P 02 (A010683)</p>	 <p><b>14.02.14</b> YAN KAPAK CAP Malzeme / Material: - Alüminyum</p>	 <p>SOLAR P 19 (A011155)</p>
	 <p><b>14.02.03</b> YAN KAPAK CAP Malzeme / Material: - Alüminyum</p>	 <p>SOLAR P 03 (A010684)</p>		